

Stair Rail Installation Instructions

Thank you for choosing Southern Vinyl Manufacturing, LLC as your stair rail provider. Please read entire instructions before installing your new vinyl stair rail.



If you also purchased porch rails, refer to the Porch Rail Installation Instructions provided with your porch rail kit. These instructions assume that steps have a typical angle between 32° and 35° and that the posts are plumb. These instructions explain how to install stair rail in a typical application. For alternate applications, or for any other vinyl fence and handrail information, visit our website www.svmlc.com.

Always check with your local building code official for regulations specific to your area.

In your stair rail kit box you will find...

- 1 Top rail
- 1 Aluminum top rail insert
- 1 Bottom rail
- 2 Top rail brackets with hardware
- 2 Bottom rail brackets with hardware
- Pickets *quantity depends on length*
 - 7 4 feet long
 - 11 6 feet long
 - 15 8 feet long
 - 19 10 feet long

Posts, Post Caps and Post Trim Rings are sold separately. Load bearing Columns, Round Column Adaptors, Wall Mounts and other accessories also available.

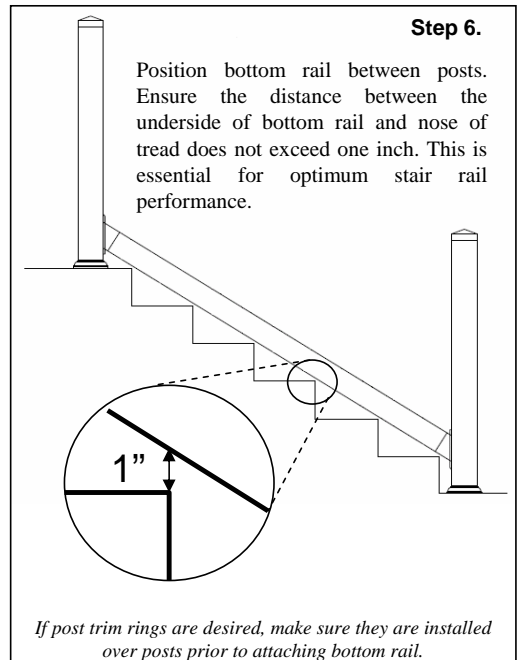
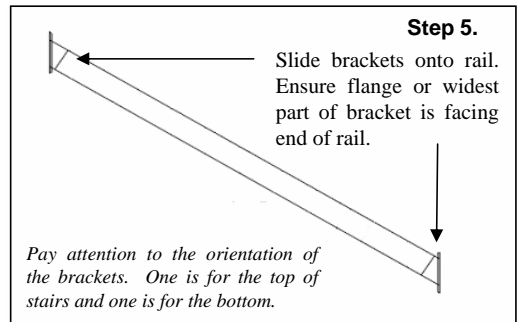
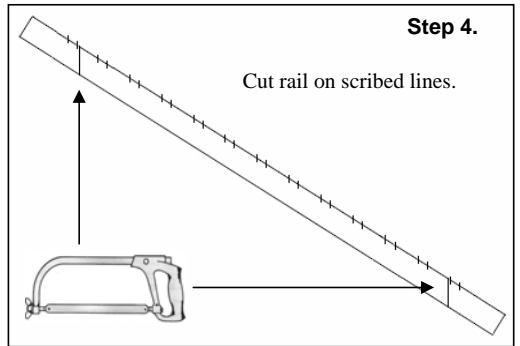
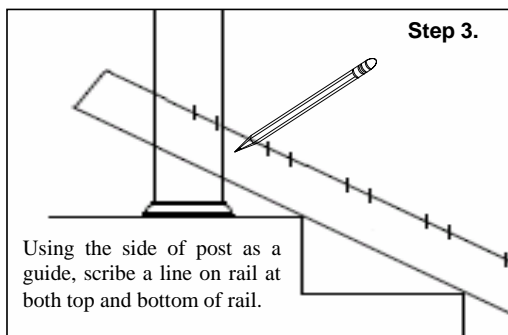
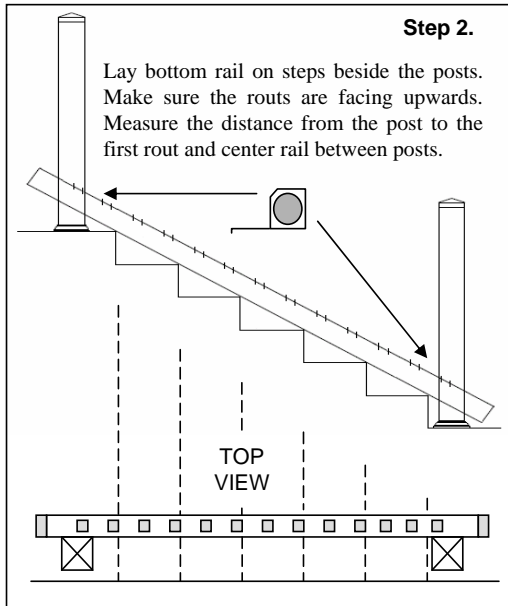
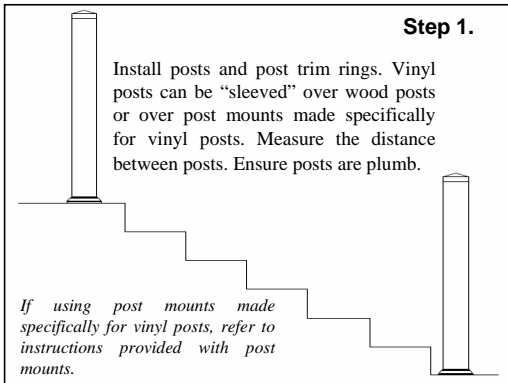

Step 7.

Attach brackets to posts using the #10-32 stainless steel screws provided. Cover the mounting screws with hole plugs supplied.

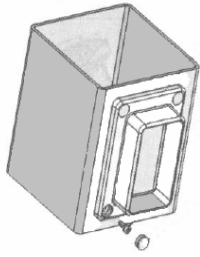

Step 8.

Install supplied stainless steel snap cap screw into side of bracket and through rail. Cover the screw head with snap cap provided.

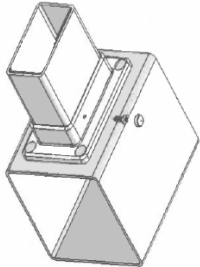

Step 9.

Insert two pickets into bottom rail. Place in the third rout from post on each end. Do not insert all the pickets at this time.

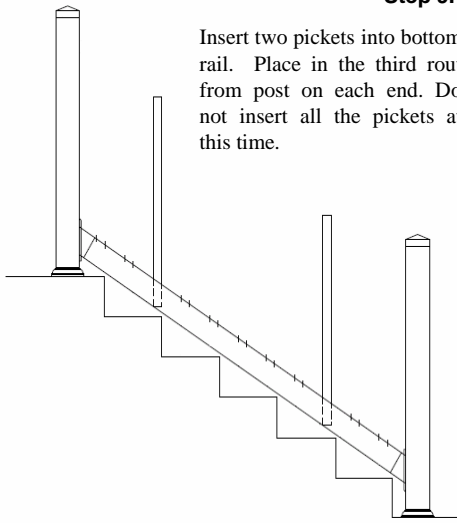

Step 12.

Insert the remainder of pickets into bottom rail. Ensure pickets insert fully into rail and extend all the way to the bottom. Pickets will insert approximately 4 inches.

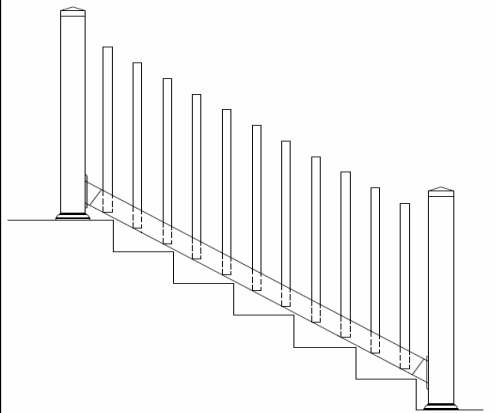

Step 10.

Temporarily remove aluminum insert from top rail and position uncut top rail onto pickets. Make sure that pickets are inserted into the same corresponding routs as bottom rail. Using a level, ensure that pickets are plumb. Scribe top rail as in Step 3. Now remove top rail.

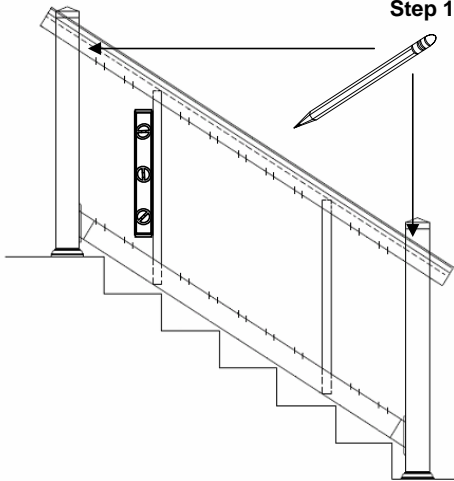

Step 13.

Reinstall the now cut top rail with aluminum insert onto pickets. Ensure pickets insert fully into top rail and extend all the way to aluminum insert (approximately 2 inches). Position and install top rail to posts. Refer to steps 7 & 8 to attach brackets.

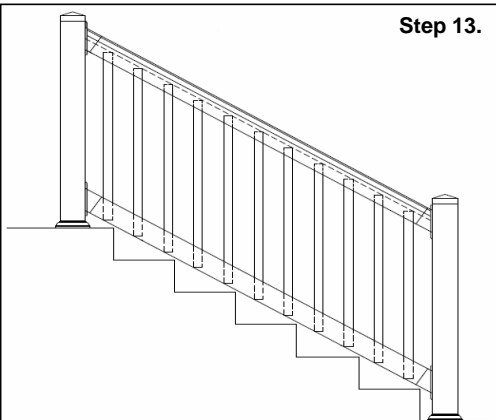

Reinsert aluminum insert into top rail and cut as in Step 4. The top rail can be cut with aluminum insert inside. Slide top rail brackets onto top rail the same as in Step 5. Pay attention to the orientation of the brackets. One bracket slopes downward, this is the bracket for top of the stairs. The bracket for the bottom of stairs slopes upward.

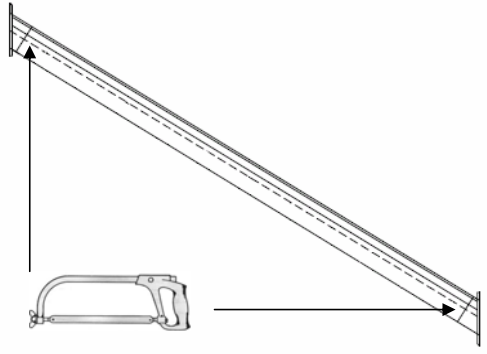

Finish your stair rail installation by installing your posts caps on your posts using a PVC rated adhesive.